



HD-MD6X2-4K-E/HD-MD4X2-4K-E/ HD-MD4X1-4K-E

4K HDMI[®] Switchers

Supplemental Guide
Crestron Electronics, Inc.

The product warranty can be found at www.crestron.com/warranty.

The specific patents that cover Crestron products are listed at patents.crestron.com.

Certain Crestron products contain open source software. For specific information, please visit www.crestron.com/opensource.

Crestron, the Crestron logo, and DigitalMedia are either trademarks or registered trademarks of Crestron Electronics, Inc. in the United States and/or other countries. HDMI, the HDMI logo, and High Definition Multimedia Interface are either trademarks or registered trademarks of HDMI Licensing LLC in the United States and/or other countries. Other trademarks, registered trademarks, and trade names may be used in this document to refer to either the entities claiming the marks and names or their products. Crestron disclaims any proprietary interest in the marks and names of others. Crestron is not responsible for errors in typography or photography.

This document was written by the Technical Publications department at Crestron.
©2016 Crestron Electronics, Inc.

Contents

Introduction	1
Using the Web Interface	1
Accessing the Web Interface.....	1
Logging In to a Switcher	2
Navigating the Web Interface	3
Viewing Status Information	4
Configuring Routes	5
Configuring Input Settings	6
Configuring Output Settings	8
Configuring Network Settings.....	10
Configuring Device Settings	11
Enabling or Disabling the Front Panel	11
Changing the Username and Password	12
Upgrading Firmware.....	13
Using the Front Panel OLED Display	14
Accessing and Navigating the OLED Display Menu	14
Configuring Input Settings	15
Configuring Output Settings	18
Configuring Network Settings.....	19
Configuring Device Settings	20
Using the Routing Push Buttons	21
Routing Inputs on the HD-MD6X2-4K-E and HD-MD4X2-4K-E	21
Routing Inputs on the HD-MD4X1-4K-E.....	22

HD-MD6X2-4K-2/HD-MD4X2-4K-E/ HD-MD4X1-4K-E: 4K HDMI® Switchers

Introduction

The Crestron® HD-MD6X2-4K-E, HD-MD4X2-4K-E, and HD-MD4X1-4K-E are 4K HDMI® switchers. Each switcher supports high-resolution signals up to 4K/60 and provides advanced DigitalMedia™ EDID management, native Crestron control via Ethernet, a built-in web server, and a front panel OLED (organic light-emitting diode) display.

While similar in functionality, the switchers differ in the number of HDMI inputs and outputs:

- The HD-MD6X2-4K-E provides six HDMI inputs and two independent HDMI outputs.
- The HD-MD4X2-4K-E provides four HDMI inputs and two independent HDMI outputs.
- The HD-MD4X1-4K-E provides four HDMI inputs and one HDMI output.

This guide provides information about configuration of the switchers using the web interface and the front panel OLED display. Information about the routing push buttons is also provided. For additional information about the switchers, refer to the HD-MD6X2-4K-E/HD-MD4X2-4K-E/HD-MD4X1-4K-E DO Guide (Doc.7760).

Using the Web Interface

Built-in web pages of the HD-MD6X2-4K-E, HD-MD4X2-4K-E, and HD-MD4X1-4K-E allow configuration of routing, input, output, network, and device settings. In addition, information about the switchers can be viewed.

Accessing the Web Interface

To access the web interface, do the following:

1. Note the IP address that appears on the front panel OLED display.

NOTE: After power is applied to a switcher, the IP address appears on the front panel OLED display.

2. Open a web browser.
3. Go to the IP address of the switcher.

The Login page opens. For login information, refer to “Logging In to a Switcher” below.

Logging In to a Switcher

The Login page allows access to the web interface of a switcher.

Login Page

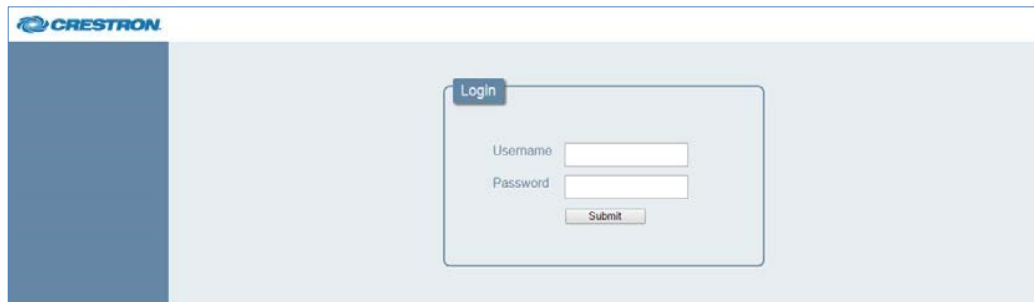
The image shows a screenshot of a web browser displaying the login page for a Crestron switcher. The page has a light blue background with a darker blue vertical bar on the left side. At the top left, the Crestron logo is visible. In the center, there is a white box with a blue border containing the login form. The form has a title 'Login' in a small blue box, followed by two input fields labeled 'Username' and 'Password', and a 'Submit' button at the bottom.

To log in to a switcher, do the following:

1. Enter the username and password. The default username is *admin*, and the default password is *admin*.

NOTE: The username and password are case sensitive.

NOTE: For enhanced security, it is recommended that the default username and password be changed. For information about changing the username and password, refer to “Changing the Username and Password” on page 12.

2. Click the **Submit** button.

The Status page opens. For information about navigating the web interface, refer to “Navigating the Web Interface” on the following page.

Navigating the Web Interface

The web interface provides a navigation bar and built-in web pages of the switchers.

Web Interface (Sample Status Page of HD-MD6X2-4K-E Shown)

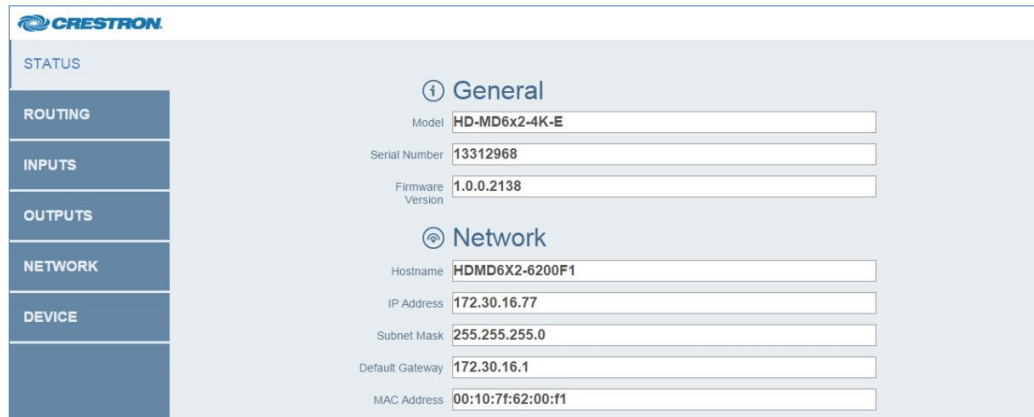

Navigation Bar	General	Network
STATUS	Model: HD-MD6x2-4K-E	Hostname: HDMD6X2-6200F1
ROUTING	Serial Number: 13312968	IP Address: 172.30.16.77
INPUTS	Firmware Version: 1.0.0.2138	Subnet Mask: 255.255.255.0
OUTPUTS		Default Gateway: 172.30.16.1
NETWORK		MAC Address: 00:10:7f:62:00:f1
DEVICE		

The navigation bar provides access to the web pages as follows:

- Clicking **STATUS** accesses the Status page, which provides general information about a switcher as well as network-related information. For additional information, refer to “Viewing Status Information” on the following page.
- Clicking **ROUTING** accesses the Routing page, which allows routes to be set on a switcher. For additional information, refer to “Configuring Routes” on page 5.
- Clicking **INPUTS** accesses the Input page, which allows the desired EDID to be sent to the inputs. For additional information, refer to “Configuring Input Settings” on page 6.
- Clicking **OUTPUT** accesses the Output page, which allows the selection of an input for routing to an output. For additional information, refer to “Configuring Output Settings” on page 8.
- Clicking **NETWORK** accesses the Network page, which allows network settings such as hostname and DHCP (Dynamic Host Configuration Protocol) mode to be set. For additional information, refer to “Configuring Network Settings” on page 10.
- Clicking **DEVICE** accesses the Device page, which allows changes to username and password settings and also controls various device functions. For additional information, refer to “Configuring Device Settings” on page 11.

NOTE: After 10 minutes of inactivity, the web interface times out and returns to the Login page.

Viewing Status Information

General information, such as model name, serial number, and firmware version of a switcher, can be viewed. The current network settings, such as hostname and IP address, can also be viewed.

To view status information, do the following: In the navigation bar, click **STATUS**. The Status page opens.

NOTE: The Status page opens after logging in to a switcher.

Sample Status Page



The screenshot shows the Crestron web interface's Status page. On the left is a navigation menu with options: STATUS, ROUTING, INPUTS, OUTPUTS, NETWORK, and DEVICE. The main content area is titled 'General' and 'Network'. The General section displays: Model (HD-MD6x2-4K-E), Serial Number (13312968), and Firmware Version (1.0.0.2138). The Network section displays: Hostname (HDMD6X2-6200F1), IP Address (172.30.16.77), Subnet Mask (255.255.255.0), Default Gateway (172.30.16.1), and MAC Address (00:10:7f:62:00:f1).

The Status page displays the following information about a switcher:

- General information, which consists of the following:
 - Model (HD-MD6x2-4K-E, HD-MD4x2-4K-E, or HD-MD4x2-4K-E)
 - Serial Number
 - Firmware Version
- Network-related information, which consists of the following:
 - Hostname

NOTE: In the sample Status page shown on the previous page for the HD-MD6X2-4K-E, the default hostname is **HDMD6X2-6200F1**, where **6200F1** consists of the last six digits of the MAC address of the HD-MD6X2-4K-E.

- IP Address
- Subnet Mask
- Default Gateway
- MAC Address

Configuring Routes

Routes can be set so that an HDMI signal from any input on a switcher can be routed to any HDMI output on the switcher.

- The HD-MD6X2-4K-E allows any of the six inputs to be routed to up to two independent outputs simultaneously.
- The HD-MD4X2-4K-E allows any of the four inputs to be routed to up to two independent outputs simultaneously.
- The HD-MD4X1-4K-E allows any of the four inputs to be routed to a single output.

To route the desired inputs to one or more HDMI outputs, do the following:

1. In the navigation bar, click **ROUTING**. The Routing page opens.

Routing Page (HD-MD6X2-4K-E Page Shown)

Input	Output 1	Output 2
0: <clear Route>	No Source	No Source
1: INPUT1		
2: INPUT2		
3: INPUT3		
4: INPUT4		
5: INPUT5		
6: INPUT6		

As shown above, the Routing page provides a list of inputs and a list of outputs.

NOTE: The Routing page varies depending on the model of the switcher. The Routing page shown above applies to the HD-MD6X2-4K-E, which has six inputs and two outputs. For the HD-MD4X2-4K-E, the Routing page lists four inputs and two outputs. For the HD-MD4X1-4K-E, the Routing page lists four inputs and one output.

The default names of the HDMI inputs are **INPUT1**, **INPUT2**, **INPUT3**, **INPUT4**, **INPUT5** (HD-MD6X2-4K-E only), and **INPUT6** (HD-MD6X2-4K-E only). For the HD-MD6X2-4K-E and HD-MD4X2-4K-E, the default names of the HDMI outputs are **OUTPUT1** and **OUTPUT2**. For the HD-MD4X1-4K-E, the default name of the HDMI output is **OUTPUT**.

2. In the text entry boxes for the inputs and outputs, rename the inputs and outputs if desired, and then click the **Save Names** button.
3. To route an input to an output, select the corresponding output radio button for the input. The input is routed to the output immediately.

NOTE: For the HD-MD6X2-4K-E and HD-MD4X2-4K-E, two output radio buttons can be selected for a single input if desired.

NOTE: For each output, the resolution and frame rate being transmitted to the output are displayed. If the input resolution is changed, the resolution and frame rate are updated dynamically. If no source is detected, the message **No Source** is displayed.

4. (Applicable to the HD-MD4X1-4K-E only) Enable or disable automatic routing:
 - To enable automatic routing, click the **TRUE** radio button if it is not already selected. By default, the **TRUE** radio button is selected.
 - To disable automatic routing, click the **FALSE** radio button.

To disconnect a route for an input, click the **<clear Route>** radio button for the corresponding output.

Configuring Input Settings

The desired EDID can be selected and sent to the inputs. Built-in EDID files are available for selection, and custom EDID files can also be selected. The EDID can be selected on a global basis and sent to all inputs, or it can be selected on an individual basis for each input. In addition, inputs can be renamed. HDCP (High-bandwidth Digital Content Protection) support can also be enabled or disabled for each input on an individual basis.

To send the desired EDID to the inputs, do the following:

1. In the navigation bar, click **INPUTS**. The Input page opens.

Input Page (HD-MD6X2-4K-E Page Shown)

The screenshot shows the Crestron web interface. On the left is a navigation menu with options: STATUS, ROUTING, INPUTS (highlighted), OUTPUTS, NETWORK, and DEVICE. The main content area is titled 'Global EDID' and includes a dropdown menu for 'Send EDID to All inputs' (currently set to 'DM default 4k 30Hz 2CH'), 'Apply to All', and 'Delete...' buttons. Below this is a 'Load CEDID file' section with a 'Choose EDID File' input field and a 'Browse...' button. The 'Inputs' section is a table with 6 rows, each representing an input. Each row has a 'Sync' radio button, a 'Name' input field, an 'EDID' dropdown menu, and an 'HDCP Support' dropdown menu. The 'Name' fields are currently empty, and the 'EDID' dropdowns are set to 'DM default 4k 30Hz 2CH'. The 'HDCP Support' dropdowns are set to 'Enabled'. Each row has 'Save' and 'Revert' buttons. At the bottom of the table is a 'Save All' button.

Sync	Name	EDID	HDCP Support	Save	Revert
1	INPUT1	DM default 4k 30Hz 2CH	Enabled	Save	Revert
2	INPUT2	DM default 4k 30Hz 2CH	Enabled	Save	Revert
3	INPUT3	DM default 4k 30Hz 2CH	Enabled	Save	Revert
4	INPUT4	DM default 4k 30Hz 2CH	Enabled	Save	Revert
5	INPUT5	DM default 4k 30Hz 2CH	Enabled	Save	Revert
6	INPUT6	DM default 4k 30Hz 2CH	Enabled	Save	Revert

NOTE: The Input page varies depending on the model of the switcher. The Input page shown above applies to the HD-MD6X2-4K-E, which has six inputs. For the HD-MD4X2-4K-E and the HD-MD4X1-4K-E, the Input page lists four inputs.

2. Determine whether a built-in EDID file or a custom EDID file is to be sent to one or more inputs. If a custom EDID file is desired, continue with step 3; otherwise, skip step 3 and proceed to step 4.
3. (For loading of custom EDID files only) In the **Global EDID** section of the page, load the desired custom EDID file by doing the following:

- a. Click the **Browse...** button located to the right of the **Load CEDID file** field. Windows Explorer opens.
- b. Navigate to the desired EDID file (*.cedid), select the file, and then click the **Open** button.

The selected EDID file appears in the **Load CEDID file** field.

- c. Click the **Load...** button. A prompt appears asking for confirmation that the EDID file be uploaded to the input device.
- d. Click the **OK** button. The following occurs:
 - In the **Global EDID** section of the page, the custom EDID filename is added to the **Send EDID to All inputs** drop-down list.
 - In the **Inputs** section of the page, the custom EDID filename is added to the **EDID** drop-down lists.

4. Configure the inputs as follows:

- a. (Optional) In the **Global EDID** section of the page, globally apply the same EDID to all inputs simultaneously by doing the following:
 - i. In the **Send EDID to All inputs** drop-down list, select the desired built-in EDID file or a custom EDID file. The built-in EDID files are as follows:

DM default 4k 30Hz 2CH (Default setting)
DM default EDID
Laptop 16x10 1280x800 2CH
Laptop 16x10 1920x1200 2CH
Laptop 16x9 1080P50 2CH
Laptop 16x9 1080P 2ch
Laptop widescreen 2CH
Consumer 4k 25Hz HBR 3D
Consumer 4k 30Hz HBR 3D
Consumer 1080P50 3D HBR
Consumer 1080P50 HBR
Consumer 1080P 3D HBR
Consumer 1080P HBR
Consumer 720P50 HBR
Consumer 720P HBR
Output 1 (HD-MD6X2-4K-E and HD-MD4X2-4K-E Only)
Output 2 (HD-MD4X2-4K-E and HD-MD4X2-4K-E Only)
Output (HD-MD4X1-4K-E Only)

NOTE: Selecting **Output 1**, **Output 2**, or **Output** copies the EDID from the output to all of the inputs.

- ii. Click the **Apply to All** button. The selected EDID is automatically sent to all inputs and appears in the **EDID** drop-down list for all inputs in the **Inputs** section of the page.

- b. In the **Inputs** section of the page, configure each input as follows:

NOTE: For each input, the Sync icon denotes whether a source is detected at the input. If a source is detected, the icon is green. If no source is detected, the icon is gray.

- i. In the **Name** text box, rename the input if desired.
- ii. If an EDID other than the Global EDID is to be assigned, select the desired EDID in the **EDID** drop-down list.
- iii. In the **HDCP Support** drop-down list, select **Enabled** or **Disabled**. The default setting is **Enabled**.
- iv. Do one of the following:
 - Click **Save** to save the **Name**, **EDID**, and **HDCP Support** entries for each corresponding input.
 - Click **Revert** to go back to the previous settings without saving the current entries.
 - Click **Save All** to save all unsaved entries.

To delete a custom EDID file, click the **Delete...** button in the **Global EDID** section of the page. The custom EDID file is deleted from the **Send EDID to All inputs** drop-down list and also from each individual **EDID** drop-down list in the **Inputs** section of the page.

NOTE: Only custom EDID files can be deleted. Built-in EDID files cannot be deleted.

Configuring Output Settings

Configuration of output settings includes the selection of an input for routing to an output, the renaming of an output, and the enabling of HDCP. Information about the connected display can also be viewed.

To configure output settings, do the following:

1. In the navigation bar, click **OUTPUTS**. The Output page opens.

Output Page (HD-MD6X2-4K-E Page Shown)

The screenshot displays the Crestron web interface for configuring outputs. On the left is a navigation menu with options: STATUS, ROUTING, INPUTS, OUTPUTS (selected), NETWORK, and DEVICE. The main content area is titled 'Outputs' and contains two configuration blocks. Each block has a 'Route' dropdown menu (set to '1: INPUT1'), a 'Transmitting' radio button, a 'Name' text input field (set to 'OUTPUT1' and 'OUTPUT2'), and an 'HDCP Output' dropdown menu (set to 'Auto'). Below each configuration is a 'Connected Display' section with fields for Manufacturer, Model, and Serial Number. At the bottom of the page is a 'Save All' button.

NOTE: The Output page varies depending on the model of the switcher. The Output page shown on the preceding page applies to the HD-MD6X2-4K-E, which has six inputs and two outputs. For the HD-MD4X2-4K-E, the Output page lists four inputs and two outputs. For the HD-MD4X1-4K-E, the Output page lists four inputs and one output.

2. For each output, do the following as appropriate:

- a. In the **Route** drop-down list, select **0: <clear Route>** to clear a route to the output, or select the desired input to set a route.

The **Transmitting** icon indicates whether an HDMI signal is being transmitted to the output:

- A green icon indicates that an HDMI signal is being transmitted to the output.
- A gray icon indicates that an HDMI signal is not being transmitted to the output.

- b. In the **Name** text entry box, rename the output if desired.

- c. In the **HDCP Output** drop-down list, select one of the following:

- **Auto:** (Default setting) Specifies that the output be encrypted if the input requires HDCP protection
- **Always Enabled:** Specifies that the output always be encrypted regardless of the input requirements

- d. Do one of the following:

- Click **Save** to save the **Route**, **Name**, and **HDCP Output** entries for each corresponding output.
- Click **Revert** to go back to the previous settings without saving the current entries.
- Click **Save All** to save all unsaved entries.

The Output page also displays the following information about the connected display:

- **Manufacturer:** Specifies the name of the manufacturer of the connected display
- **Model:** Specifies the model name of the connected display
- **Serial Number:** Specifies the serial number of the connected display

Configuring Network Settings

To configure network settings, do the following:

1. In the navigation bar, click **NETWORK**. The Network page opens.

Network Page

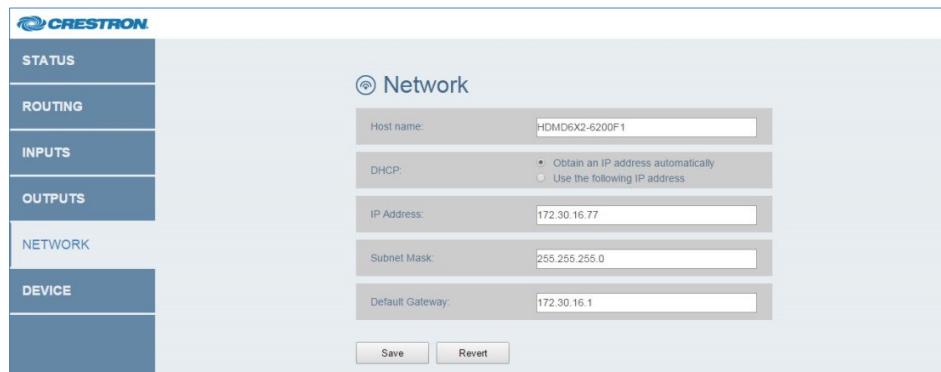

2. Configure network settings as required:

- In the **Hostname** text box, overwrite the existing hostname with a name that identifies the switcher on the network. The hostname is restricted to the letters *a* to *z* (not case sensitive), the digits *1* to *9*, and the hyphen.

The default hostname is HDMD6X2-xxxxxx for the HDMD6X2-4K-E, HDMD4X2-xxxxxx for the HD-MD4X2-4K-E, and HDMD4X1-xxxxxx for the HD-MD4X1-4K-E, where xxxxxx consists of the last six digits of the MAC address of the device.

- Specify whether the IP address of the switcher is to be assigned by a DHCP (Dynamic Host Configuration Protocol) server. To set the IP address, click either of the following radio buttons:
 - **Obtain an IP address automatically:** (Default setting) Allows the IP address of the switcher to be automatically assigned by a DHCP server on the local area network (LAN) for a predetermined period of time.

NOTE: If a DHCP server does not exist on the network and 45 seconds have elapsed since the switcher was powered on, the IP address defaults to a link-local address. Refer to RFC 3927 for information about link-local addressing.

- **Use the following IP address:** Allows static IP address, subnet mask, and default gateway settings to be configured:
 - **IP Address:** Enter a unique IP address for the switcher.
 - **Subnet Mask:** Enter the subnet mask that is set on the network.
 - **Default Gateway:** Enter the IP address that is to be used as the network's gateway.

3. Do either of the following:
 - To save the current entries, click the **Save** button. The switcher automatically reboots.
 - To go back to the previous settings without saving the current entries, click the **Revert** button.

Configuring Device Settings

Configuration and management of device settings consist of the following:

- Enabling or disabling the front panel
- Changing the user name and password
- Upgrading firmware

Enabling or Disabling the Front Panel

By default, the front panel of the switcher is enabled, allowing the navigation pad of the OLED display as well as the routing push buttons to function. The navigation pad and routing push buttons can be disabled. In addition, the OLED display and all LEDs on a switcher can be turned off. Although the switcher appears as though it is not powered on and functioning, the device remains powered on and continues to function.

NOTE: For information about the OLED display, refer to “Using the Front Panel OLED Display” on page 14. For information about the routing push buttons, refer to “Using the Routing Push Buttons” on page 21.

To enable or disable the front panel, do the following:

1. In the navigation bar, click **DEVICE**. The Device page, which includes a **Front Panel** section, opens.

Device Page—Front Panel

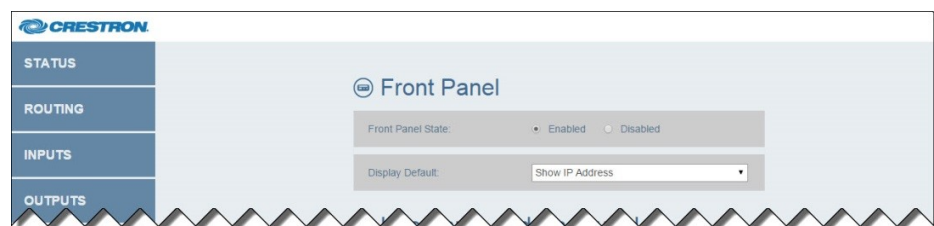

2. Configure front panel settings as desired:
 - a. Enable or disable the front panel. To enable the front panel, click the **Enabled** radio button if it is not already selected. To disable the front panel, click the **Disabled** radio button. When the front panel is disabled, the navigation pad of the OLED display as well as the **INPUT** and **OUTPUT** push buttons are disabled.
 - b. In the **Display Default** drop-down list, select one of the following to control the information that appears on the OLED display or to enable or disable the OLED display:
 - **Show IP Address:** (Default setting) Allows the IP address of the switcher to be shown on the OLED display

- **Show video routing:** Allows the route for each output to be shown on the OLED display. For each of the two outputs of the HD-MD6X2-4K-E and HD-MD4X2-4K-E, the output name followed by the corresponding input name is displayed, for example:

OUTPUT1: INPUT1
OUTPUT2: INPUT 4

For the single output of the HD-MD4X1-4K-E, the output name followed by the corresponding input name is displayed, for example:

OUTPUT: INPUT1

- **Disable:** Turns off the OLED display, preventing the IP address or video routing information from being shown on the display. In addition, the PWR LED and the INPUT and OUTPUT LEDs also turn off.

Changing the Username and Password

To change the username and password, do the following:

1. In the navigation bar, click **DEVICE**. The Device page, which includes a **Username and Password** section, opens.

Device Page—Username and Password

2. Do the following:

NOTE: The username and password are case sensitive.

- a. In the **Username** text box, enter the desired username.
- b. In the **Password** text box, enter the desired password.
- c. In the **Confirm Password** text box, reenter the desired password to confirm the password.
- d. Do either of the following:
 - To save the current entries, click the **Save** button.
 - To go back to the previous settings without saving the current entries, click the **Revert** button.

Upgrading Firmware

To upgrade firmware of the switcher, do the following:

1. In the navigation bar, click **DEVICE**. The Device page, which includes a **Firmware** section, opens.

Device Page—Firmware

Model	HD-MD6X2-4K-E
Serial Number	13312968
Firmware Version	1.0.0.2138

Upload firmware file:
Choose Firmware File

Use service port:

The **Firmware** section displays the following information about the switcher:

- Model, which is **HD-MD6X2-4K-E**, **HD-MD4X2-4K-E**, or **HD-MD4X1-4K-E**
 - Serial Number
 - Firmware Version
2. To upgrade the firmware, click the **Upload firmware file** radio button or the **Use service port** radio button:
 - If the **Upload firmware file** radio button is selected, do the following:
 - a. Click the **Browse** button. Windows Explorer opens.
 - b. Locate and select the desired firmware file (*.bin), and then click the **Open** button. The **Browse** field displays the firmware filename.
 - c. Click the **Load** button. A prompt appears asking for confirmation that the firmware be upgraded.
 - d. Click the **OK** button to upgrade the firmware.
 - If the **Use service port** radio button is selected, do the following:
 - a. Insert a USB mass storage device containing the firmware file into the **SERVICE** port of the switcher.
 - b. Click the **Load** button. A prompt appears asking for confirmation that the firmware be upgraded.
 - c. Click the **OK** button to upgrade the firmware.

Using the Front Panel OLED Display

The front panel OLED display provides a menu that allows configuration of the switchers. The following illustration provides a menu tree of the OLED display.

OLED Display Menu Tree

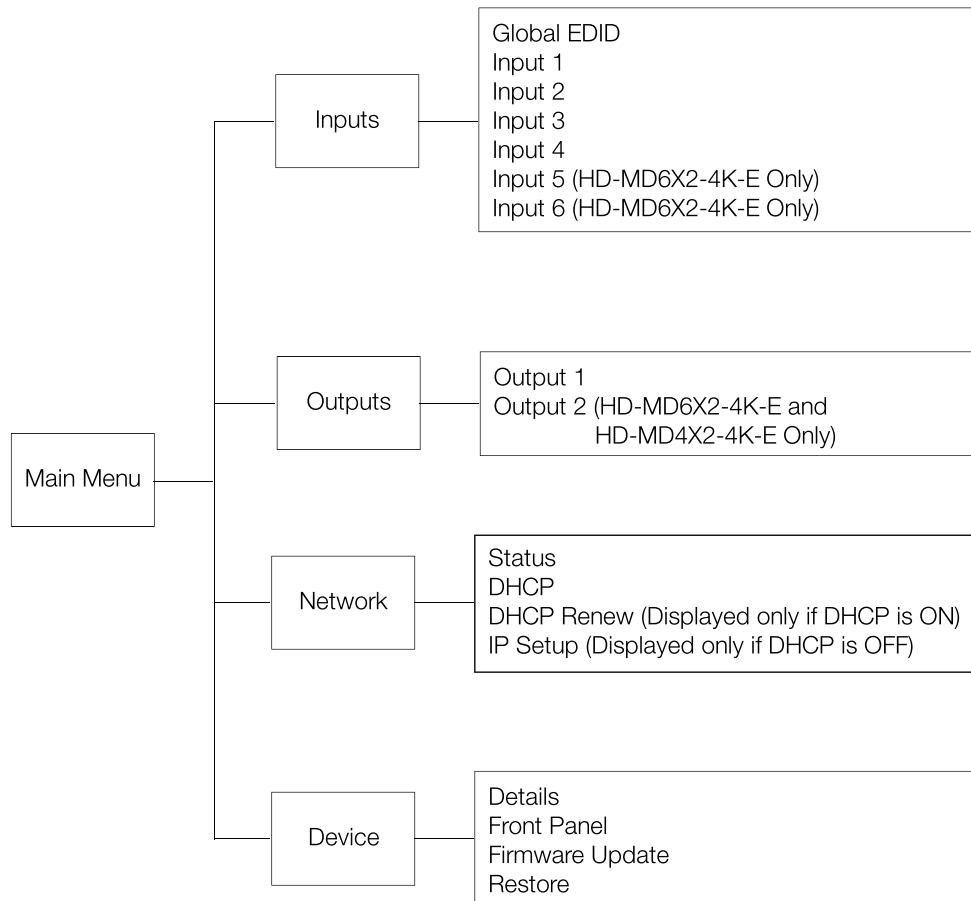

The following sections provide information about the OLED display menu.

Accessing and Navigating the OLED Display Menu

To access and navigate the OLED display menu, use the OLED push buttons and the navigation pad on the front panel of the switchers.

OLED Push Buttons and Navigation Pad (HD-MD6X2-4K-E Shown)

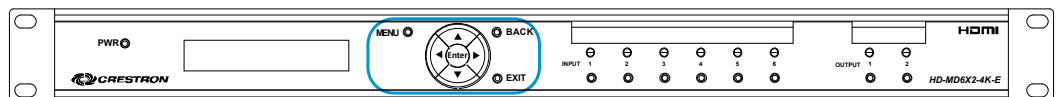

To access the main menu of the OLED display, press the **MENU** button. The OLED display, which displays two lines at a time, appears as shown on the following page.

OLED Main Menu

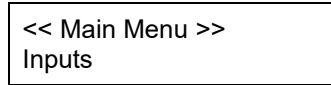

To navigate the main menu and submenus on the OLED display, do the following:

- To navigate upward in a menu, press the up button (▲) on the navigation pad.
- To navigate downward in a menu, press the down button (▼) on the navigation pad.
- To move the cursor to the left when entering data, press the left button (◀) on the navigation pad.
- To move the cursor to the right when entering data, press the right button (▶) on the navigation pad.
- To select an item in a menu, press the **Enter** button on the navigation pad.
- To save a new setting, press the **Enter** button on the navigation pad.
- To go back to the previous level in a menu, press the **BACK** button on the front panel.
- To exit the menu of the OLED display, press the **EXIT** button on the front panel.

Configuring Input Settings

To configure input settings, do the following:

1. On the main menu, select **Inputs**. The Inputs submenu opens.

Inputs Submenu

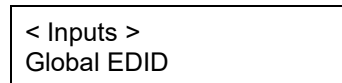

Available selections are as follows:

- Global EDID
- Input 1
- Input 2
- Input 3
- Input 4
- Input 5 (applicable to the HD-MD6X2-4K-E only)
- Input 6 (applicable to the HD-MD6X2-4K-E only)

2. Configure inputs as follows:
 - a. (Optional) Select **Global EDID**.

The following message flashes across the OLED: **Apply EDID to All Inputs**

- i. Confirm the selection by pressing the **Enter** button. A list of EDID files is presented.

DM default 4k 30Hz 2CH (Default setting)
DM default EDID
Laptop 16x10 1280x800 2CH
Laptop 16x10 1920x1200 2CH
Laptop 16x9 1080P50 2CH
Laptop 16x9 1080P 2ch

Laptop widescreen 2CH
Consumer 4k 25Hz HBR 3D
Consumer 4k 30Hz HBR 3D
Consumer 1080P50 3D HBR
Consumer 1080P50 HBR
Consumer 1080P 3D HBR
Consumer 1080P HBR
Consumer 720P50 HBR
Consumer 720P HBR
External EDID 1
External EDID 2
External EDID 3
External EDID 4
External EDID 5
External EDID 6
External EDID 7
External EDID 8
Copy Output 1
Copy Output 2 (applicable to the HD-MD6X2-4K-E and
HD-MD4X2-4K-E only)

NOTE: In the list above, **External EDID 1** through **External EDID 8** represent placeholders for custom-loaded EDID files.

NOTE: Selecting **Output 1** or **Output 2** copies the EDID from the output to all of the inputs.

ii. Select the desired EDID.

A prompt appears asking for confirmation that the selected EDID be applied to all inputs.

iii. Select **Yes** or **No**:

- If **Yes** is selected, the **Setting...** message appears, and then the OLED display returns to the Inputs submenu.
- If **No** is selected, the OLED display returns to the list of available EDIDs.

b. Configure each input on an individual basis by selecting the input number in the Inputs submenu.

The Input Status and Configuration submenu opens for the selected input.

Input Status and Configuration Submenu (Input 1 Shown)

< Input 1 > Status

Items on the Input Status and Configuration submenu are listed in the following table. Refer to the table for configuration guidelines.

Input Status and Configuration Submenu Guidelines

SUBMENU ITEM	GUIDELINES
Status	(Read Only) Indicates whether a source is detected at the input: Sync ON or Sync OFF
Name	Allows renaming of an input. To rename an input, use the up (▲) and down (▼) buttons to enter capital letters, lowercase letters, numbers, a plus sign (+), a minus sign (-), a left bracket ([), and a right bracket (]). To move the cursor to the left or right when renaming an input, press the left (◀) or right (▶) button, respectively. To save the name, press the Enter button. The message Saving... Complete is displayed.
EDID	<p>Displays the current EDID. If an EDID other than the Global EDID is to be assigned, select the desired EDID. Available selections are as follows:</p> <ul style="list-style-type: none"> DM default 4k 30Hz 2CH (Default setting) DM default EDID Laptop 16x10 1280x800 2CH Laptop 16x10 1920x1200 2CH Laptop 16x9 1080P50 2CH Laptop 16x9 1080P 2ch Laptop widescreen 2CH Consumer 4k 25Hz HBR 3D Consumer 4k 30Hz HBR 3D Consumer 1080P50 3D HBR Consumer 1080P50 HBR Consumer 1080P 3D HBR Consumer 1080P HBR Consumer 720P50 HBR Consumer 720P HBR External EDID 1 External EDID 2 External EDID 3 External EDID 4 External EDID 5 External EDID 6 External EDID 7 External EDID 8 Copy Output 1 Copy Output 2 (applicable to the HD-MD6X2-4K-E and HD-MD4X2-4K-E only) <p>When an EDID is selected, the Setting... message is displayed. NOTE: In the list above, External EDID 1 through External EDID 8 represent placeholders for custom-loaded EDID files.</p>
HDCP	Enables or disables HDCP. Select Enable or Disable . The default setting is Enable . An asterisk precedes the current setting.

Configuring Output Settings

To configure output settings, do the following:

1. On the main menu, select **Outputs**. The Outputs submenu opens.

Outputs Submenu of HD-MD6X2-4K-E and HD-MD4X2-4K-E

```
< Outputs >
Output 1
```

Outputs Submenu of HD-MD4X1-4K-E

```
< Outputs >
Output
```

Available selections for the HD-MD6X2-4K-E and HD-MD4X2-4K-E, each of which contains two outputs, are **Output 1** and **Output 2**. Since the HD-MD4X1-4K-E contains only one output, the available selection is **Output**.

2. Configure an output by selecting the output in the Outputs submenu.

The Output Configuration submenu opens for the selected output.

Output Configuration Submenu of HD-MD6X2-4K-E and HD-MD4X2-4K-E (Output 1 Shown)

```
< Output 1 >
Status
```

Output Configuration Submenu of HD-MD4X2-4K-E

```
< Output >
Status
```

Items on the Output Configuration submenu are listed in the following table. Refer to the table for configuration guidelines.

Output Configuration Submenu Guidelines

SUBMENU ITEM	GUIDELINES
Status	(Read Only) Displays the manufacturer, model, and serial number of the connected display
Name	Allows renaming of an output. To rename an output, use the up (▲) and down (▼) buttons to enter capital letters, lowercase letters, numbers, a plus sign (+), a minus sign (-), a left bracket ([), and a right bracket (]). To move the cursor to the left or right when renaming an output, press the left (◀) or right (▶) button, respectively. To save the name, press the Enter button. The message Saving... Complete is displayed.
HDCP Output	Controls the enabling of HDCP for the output. Select either of the following: <ul style="list-style-type: none"> • Auto: Specifies that the output be encrypted if the input requires HDCP • Always Enabled: Specifies that the output always be encrypted regardless of the input requirements

Configuring Network Settings

To configure network settings, do the following: On the main menu, select **Network**. The Network Status and Configuration submenu opens.

Network Status and Configuration Submenu

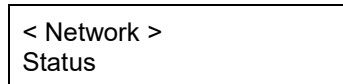

Available selections are as follows:

- Status
- DHCP
- DHCP Renew (Displayed only when DHCP is set to ON)
- IP Setup (Displayed only when DHCP is set to OFF)

Items on the Network Status and Configuration submenu are listed in the following table. Refer to the table for configuration guidelines.

Network Status and Configuration Submenu Guidelines

SUBMENU ITEM	GUIDELINES
Status	(Read Only) Provides the following network-related information: <ul style="list-style-type: none"> • DHCP: Indicates whether DHCP is on or off • IP Address: Displays the IP address of the switcher • Subnet Mask: Displays the subnet mask that is set on the network • Gateway: Displays the IP address that is used as the network's gateway • MAC Address: Displays the MAC address of the device
DHCP	Set DHCP to ON or OFF . The default setting is ON . An asterisk precedes the current setting.
DHCP Renew	(Displayed only when DHCP is set to ON) Select DHCP Renew to obtain a new IP address lease.
IP Setup	(Displayed only when DHCP is set to OFF) Enter the following network-related information: <ul style="list-style-type: none"> • IP Address: Enter a unique IP address for the switcher. • Subnet Mask: Enter the subnet mask that is set on the network. • Gateway: Enter the IP address that is used as the network's gateway To enter an address, use the navigation pad. Press the up (▲) and down (▼) buttons as appropriate to enter each octet in an address. To move to the previous octet in an address, press the left (◀) button. To move to the next octet in an address, press the right (▶) button. To save an address, press the Enter button.

Configuring Device Settings

To configure device settings, do the following: On the main menu, select **Device**. The Device Status and Configuration submenu opens.

Device Status and Configuration Submenu

<p>< Device > Details</p>

Available selections are as follows:

- Details
- Front Panel
- Firmware Update
- Restore

Items on the Device Status and Configuration submenu are listed in the following table. Refer to the table for configuration guidelines.

Device Status and Configuration Submenu Guidelines

SUBMENU ITEM	GUIDELINES
Details	(Read Only) Display the following information about the switcher: <ul style="list-style-type: none"> • S/N: Specifies the serial number of the switcher • FW Ver.: Specifies the firmware version of the switcher
Front Panel	Controls the information that appears on the OLED display or disables the OLED display and all controls on the switcher. Select one of the following: <ul style="list-style-type: none"> • Show IP Address: (Default setting) Allows the IP address of the switcher to be shown on the OLED display • Show Video Routing: Allows the route for each output to be shown on the OLED display • Disable: Disables the OLED display, navigation pad, push buttons, and LEDs on the switcher. Although the front panel is set to Disable, the device continues to function. <p>NOTE: To enable the OLED display, navigation pad, push buttons, and LEDs, press and hold the INPUT 1 push button for 3 seconds.</p> <p>An asterisk precedes the current setting.</p>
Firmware Update	When selected, a prompt appears asking for confirmation that the firmware be updated. Select Yes or No . If Yes is selected and a USB mass storage device is not inserted into the SERVICE port of the switcher, the Insert USB drive message appears on the OLED display. To update the firmware, insert a USB mass storage device containing the updated firmware file into the SERVICE port.
Restore	When selected, a prompt appears asking for confirmation that the default settings be restored. Select Yes or No . If Yes is selected, the Restoring... message appears followed by the Restoring ... Complete message.

Using the Routing Push Buttons

The switchers provide routing push buttons that can be used to route inputs to outputs. Routing LEDs indicate the routing status.

NOTE: Both the web interface and the OLED display menu allow the front panel to be disabled. If the front panel is disabled, pressing the routing push buttons has no effect. (For information about enabling or disabling the front panel by using the web interface, refer to “Enabling or Disabling the Front Panel” on page 11. For information about enabling or disabling the front panel by using the OLED display, refer to “Configuring Device Settings” on page 20.)

Routing Inputs on the HD-MD6X2-4K-E and HD-MD4X2-4K-E

The HD-MD6X2-4K-E provides six **INPUT** push buttons numbered 1-6, two **OUTPUT** push buttons numbered 1 and 2, and corresponding LEDs.

Routing Push Buttons and LEDs on the HD-MD6X2-4K-E

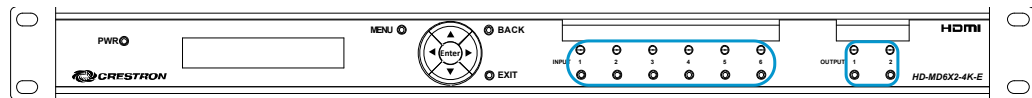

The HD-MD4X2-4K-E provides four **INPUT** push buttons numbered 1-4, two **OUTPUT** push buttons numbered 1 and 2, and corresponding LEDs.

Routing Push Buttons and LEDs on the HD-MD4X2-4K-E

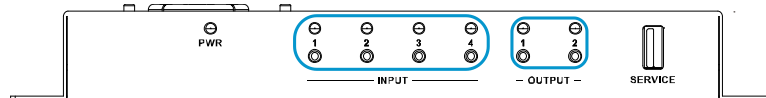

To route an input to an output on the HD-MD6X2-4K-E or HD-MD4X2-4K-E, press the **INPUT** push button corresponding to the input to be routed, and then press one or both of the **OUTPUT** push buttons as desired.

NOTE: For the HD-MD6X2-4K-E and HD-MD4X2-4K-E, the two **OUTPUT** buttons can be pressed for the selected input if desired.

When an **INPUT** push button is pressed, the corresponding **INPUT** LED indicates whether the input is routed. The following table provides information about the **INPUT** LEDs.

INPUT LED Colors and Meaning (HD-MD6X2-4K-E and HD-MD4X2-4K-E Only)

COLOR	MEANING
Solid green	The input is routed to an output.
Flashing green	The input is in the pending state and will be routed to an output when the desired OUTPUT push button is pressed. If an OUTPUT push button is not pressed within 15 seconds, the INPUT LED turns off.
Amber	A source is detected but no signal is routed.
Off	No source is detected and no signal is routed.

When an **OUTPUT** button is pressed, the corresponding OUTPUT LED indicates whether a sink is detected and video is transmitted. The following table provides information about the OUTPUT LEDs.

OUTPUT LED Colors and Meaning (HD-MD6X2-4K-E and HD-MD4X2-4K-E Only)

COLOR	MEANING
Green	The output is transmitting video.
Amber	A sink is detected but no video is being transmitted.
Off	No sink is detected and no video is being transmitted.

Routing Inputs on the HD-MD4X1-4K-E

The HD-MD4X1-4K-E provides one **AUTO** push button, four **INPUT** push buttons numbered 1-4, and corresponding LEDs.

Routing Push Buttons and LEDs on the HD-MD4X1-4K-E

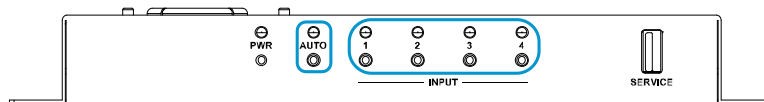

To route an input on the HD-MD4X1-4K-E, do either of the following:

- Enable automatic routing. By default, automatic routing of the inputs is enabled. Pressing the **AUTO** push button toggles automatic routing on and off.

When the automatic routing is enabled, the AUTO LED lights green. When automatic routing is disabled, the AUTO LED turns off.

- Press the **INPUT** push button corresponding to the input to be routed.

When an **INPUT** push button is pressed, the corresponding INPUT LED indicates whether the input is routed. The following table provides information about the INPUT LEDs.

INPUT LED Colors and Meaning (HD-MD4X1-4K-E Only)

COLOR	MEANING
Green	The input is routed to the output.
Amber	A source is detected but no signal is routed.
Off	No source is detected and no signal is routed.

This page is intentionally left blank.

Crestron Electronics, Inc.
15 Volvo Drive Rockleigh, NJ 07647
Tel: 888.CRESTRON
Fax: 201.767.7576
www.crestron.com

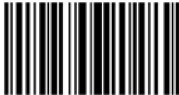

**Supplemental Guide – DOC. 7761A
(2045812)**

01.16
Specifications subject to
change without notice.