

Hardware User Guide

CORE 510i – Integrated Core Processor

CORE 510c – Cinema Core Processor

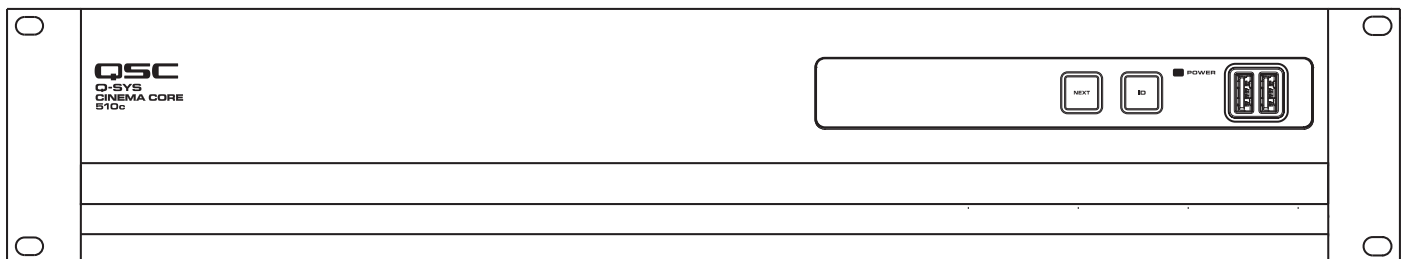
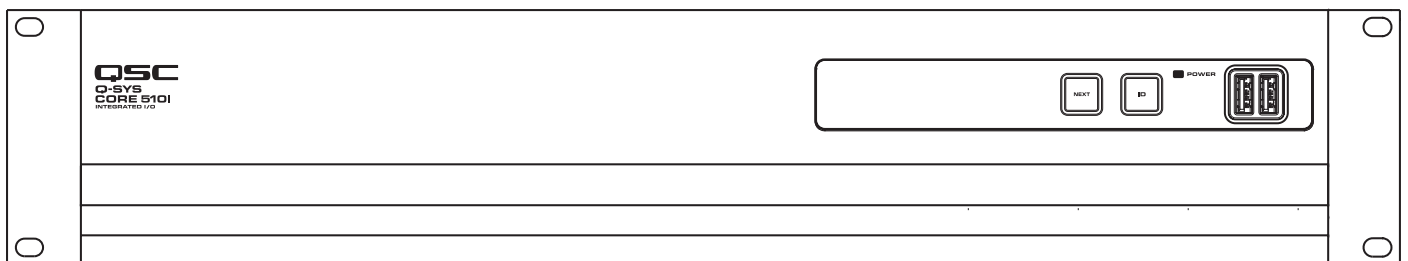

EXPLANATION OF TERMS AND SYMBOLS

The term “**WARNING!**” indicates instructions regarding personal safety. If the instructions are not followed the result may be bodily injury or death.

The term “**CAUTION!**” indicates instructions regarding possible damage to physical equipment. If these instructions are not followed, it may result in damage to the equipment that may not be covered under the warranty.

The term “**IMPORTANT!**” indicates instructions or information that are vital to the successful completion of the procedure.

The term “**NOTE**” is used to indicate additional useful information.



The intent of the lightning flash with arrowhead symbol in a triangle is to alert the user to the presence of un-insulated "dangerous" voltage within the product's enclosure that may be of sufficient magnitude to constitute a risk of electric shock to humans.



The intent of the exclamation point within an equilateral triangle is to alert the user to the presence of important safety, and operating and maintenance instructions in this manual.



IMPORTANT SAFETY INSTRUCTIONS



WARNING!: TO PREVENT FIRE OR ELECTRIC SHOCK, DO NOT EXPOSE THIS EQUIPMENT TO RAIN OR MOISTURE. **Elevated Operating Ambient** - If installed in a closed or multi-unit rack assembly, the ambient operating temperature of the rack environment may be greater than room ambient. Consideration should be given to ensure that the maximum operating temperature range (0°C to 50°C (32°F to 122°F)) is not exceeded. **Reduced Air Flow** – Installation of the equipment in a rack should be such that the amount of air flow required for safe operation of the equipment is not compromised.

1. Read these instructions.
2. Keep these instructions.
3. Heed all warnings.
4. Follow all instructions.
5. Do not use this apparatus near water.
6. Do not submerge the apparatus in water or liquids.
7. Do not use any aerosol spray, cleaner, disinfectant or fumigant on, near or into the apparatus.
8. Clean only with a dry cloth.
9. Do not block any ventilation opening. Install in accordance with the manufacturer's instructions.
10. Keep all ventilation openings free of dust or other matter.
11. Do not install near any heat sources such as radiators, heat registers, stoves, or other apparatus (including amplifiers) that produce heat.
12. To reduce the risk of electrical shock, the power cord shall be connected to a mains socket outlet with a protective earthing connection.
13. Do not defeat the safety purpose of the polarized or grounding-type plug. A polarized plug has two blades with one wider than the other. A grounding type plug has two blades and a third grounding prong. The wide blade or the third prong are provided for your safety. If the provided plug does not fit into your outlet, consult an electrician for replacement of the obsolete outlet.
14. Protect the power cord from being walked on or pinched particularly at plugs, convenience receptacles, and the point where they exit from the apparatus.
15. Do not unplug the unit by pulling on the cord, use the plug.
16. Only use attachments/accessories specified by the manufacturer.
17. Unplug this apparatus during lightning storms or when unused for long periods of time.
18. Refer all servicing to qualified service personnel. Servicing is required when the apparatus has been damaged in any way, such as power-supply cord or plug is damaged, liquid has been spilled or objects have fallen into the apparatus, the apparatus has been exposed to rain or moisture, does not operate normally, or has been dropped.

19. The appliance coupler, or the AC Mains plug, is the AC mains disconnect device and shall remain readily accessible after installation.
20. Adhere to all applicable, local codes.
21. Consult a licensed, professional engineer when doubt or questions arise regarding a physical equipment installation.

Maintenance and Repair



WARNING!: Advanced technology, e.g., the use of modern materials and powerful electronics, requires specially adapted maintenance and repair methods. To avoid a danger of subsequent damage to the apparatus, injuries to persons and/or the creation of additional safety hazards, all maintenance or repair work on the apparatus should be performed only by a QSC authorized service station or an authorized QSC International Distributor. QSC is not responsible for any injury, harm or related damages arising from any failure of the customer, owner or user of the apparatus to facilitate those repairs.

Lithium Battery Warning



WARNING!: THIS EQUIPMENT CONTAINS A NON-RECHARGEABLE LITHIUM BATTERY. LITHIUM IS A CHEMICAL KNOWN TO THE STATE OF CALIFORNIA TO CAUSE CANCER OR BIRTH DEFECTS. THE NON-RECHARGEABLE LITHIUM BATTERY CONTAINED IN THIS EQUIPMENT MAY EXPLODE IF IT IS EXPOSED TO FIRE OR EXTREME HEAT. DO NOT SHORT CIRCUIT THE BATTERY. DO NOT ATTEMPT TO RECHARGE THE NON-RECHARGEABLE LITHIUM BATTERY. THERE IS A RISK OF EXPLOSION IF THE BATTERY IS REPLACED BY AN INCORRECT TYPE.

FCC Statement

This equipment has been tested and found to comply with the limits for a Class A digital device, pursuant to Part 15 of the FCC Rules. These limits are designed to provide reasonable protection against harmful interference when the equipment is operated in a commercial environment. This equipment generates, uses, and can radiate radio frequency energy and, if not installed and used in accordance with the instruction manual, may cause harmful interference to radio communications. Operation of this equipment in a residential area is likely to cause harmful interference in which case the user will be required to correct the interference at his own expense.

Expected Product Life Cycle: 20 years, **Storage Temperature range:** -20°C to + 70°C, **Relative Humidity:** range of 5 - 85% RH non-condensing.

Warranty

For a copy of the QSC Limited Warranty, visit the QSC, LLC., website at www.qsc.com

Para una copia de la Garantía Limitada de QSC, visite el sitio web de QSC, LLC., en www.qsc.com

Pour obtenir une copie de la garantie limitée de QSC, visitez le site de QSC, LLC. à www.qsc.com

Besuchen Sie die Webseite von QSC, LLC. (www.qsc.com) um eine Kopie der beschränkten Garantie von QSC zu erhalten.

如果您想要QSC有限保修的複印本, 請造訪QSC音頻產品的網站www.qsc.com

Для получения копии ограниченной гарантии QSC посетите веб-сайт QSC, LLC., расположенный по адресу www.qsc.com.

للحصول على نسخة من الضمان المحدود الخاص بـQSC، قم بزيارة الموقع الإلكتروني لشركة QSC للمنتجات الصوتية على www.qsc.com

QSC限定保証の複製には、QCSのウェブサイトwww.qsc.comにアクセスしてください。

RoHS Statement

The QSC Q-SYS Core 510 Series is in compliance with European Directive 2011/65/EU – Restriction of Hazardous Substances (RoHS2).

The QSC Q-SYS Core 510 Series is in compliance with “China RoHS” directives. The following chart is provided for product use in China and its territories:

		QSC Q-SYS Core 510 Series				
部件名称 (Part Name)	有害物质 (Hazardous Substances)					
	铅 (Pb)	汞 (Hg)	镉 (Cd)	六价铬 (Cr(vi))	多溴联苯 (PBB)	多溴二苯醚 (PBDE)
电路板组件 (PCB Assemblies)	X	0	0	0	0	0
机壳装配件 (Chassis Assemblies)	X	0	0	0	0	0

本表格依据 SJ/T 11364 的规定编制。

0: 表示该有害物质在该部件所有均质材料中的含量均在 GB/T 26572 规定的限量要求以下。

X: 表示该有害物质至少在该部件的某一均质材料中的含量超出 GB/T 26572 规定的限量要求。

(目前由于技术或经济的原因暂时无法实现替代或减量化。)



This table is prepared following the requirement of SJ/T 11364.

O: Indicates that the concentration of the substance in all homogeneous materials of the part is below the relevant threshold specified in GB/T 26572.

X: Indicates that the concentration of the substance in at least one of all homogeneous materials of the part is above the relevant threshold specified in GB/T 26572.

(Replacement and reduction of content cannot be achieved currently because of the technical or economic reason.)

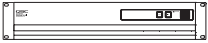
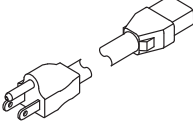
Package Contents

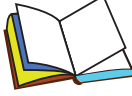
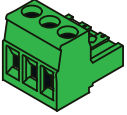
 <p>Core 510</p>	 <p>AC Power cord</p>	 <p>Safety and Regulatory Statements TD-001514</p>	 <p>QSC Warranty TD-000453</p>
 <p>Connectors with some I/O cards</p>			

Installation

The following steps are written in the recommended installation order.

Rack-Mounting

Rack mount the Q-SYS product by supporting it from underneath while aligning the front panel mounting holes (in the rack ears) with the threaded screw holes in the rack rails. Install all four mounting screws and washers and tighten securely. This Q-SYS product comes with rear rack support ears. Ensure that these rear mounting points are securely fastened to rear rack rails or side walls.



WARNING! **Reliable Earthing** — Reliable earthing of rack-mounted equipment should be maintained. Particular attention should be given to supply connections other than direct connections to the branch circuit (e.g. use of power strips). **Mechanical Loading** — Mounting the equipment in the rack should be done such that a hazardous condition is not achieved due to uneven or unstable mechanical loading

Features

Front Panel

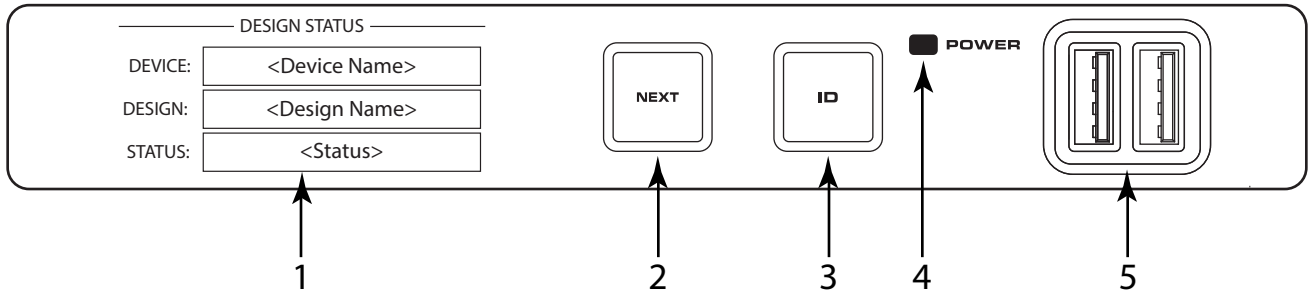

— Figure 1 —

1. **OLED Display** – Displays information about the Core's settings and status.
2. **NEXT button** – Cycles through the OLED information pages
3. **ID button** – Locates the Core in Q-SYS Designer GUI and Configurator
4. **POWER LED** – Illuminates blue when the Core is on
5. **USB Ports** – USB Type A Host connectors (2)

Rear Panel

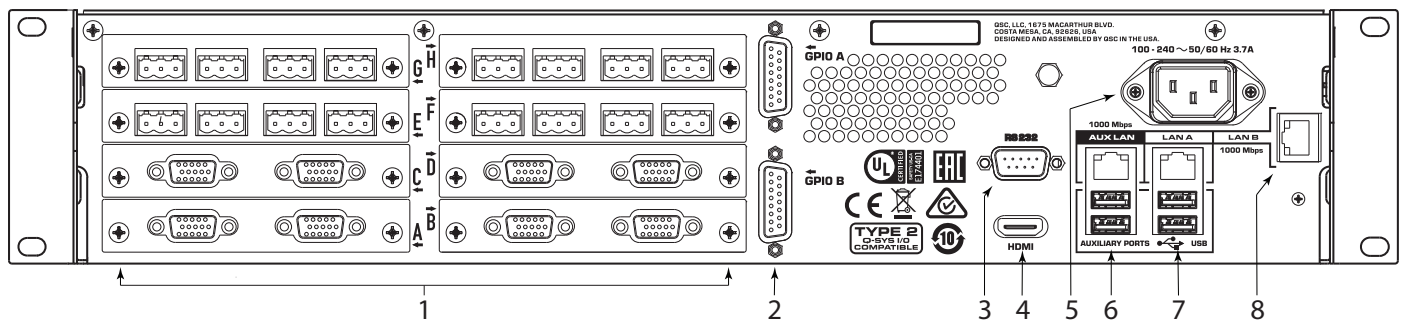

— Figure 2 —

1. **Eight Audio I/O Card Bays** – Accept Q-SYS Type 2 Audio I/O Cards (supports up to 128x128 local audio channels)
 2. **GPIO A and GPIO B** – Female DA-15 connectors for Q-SYS control I/O
 3. **RS232** – Male DE-9 serial communications interface
 4. **HDMI** – Video Output
 5. **AC Mains** – IEC 60320 C14 receptacle
 6. **AUX LAN** – RJ45: Data, VoIP, WAN streaming, management
 7. **LAN A** – RJ45: Q-LAN, AES67, Audio, VoIP, management
 8. **LAN B** – RJ45: Q-LAN, AES67, Audio, VoIP, management
- Auxiliary Ports** – USB Type A Host Ports
- Auxiliary Ports** – USB Type A Host Ports

Front Panel OLED Screens

Design Status

Refer to Figure 3

- **Device** – The name of the Core as defined in Q-SYS Designer.
- **Design** – The name of the currently running design.
- **Status** – Indicates health of Core in design:
 - OK** – Audio, Video and Control (AVC) engine is good.

Compromised – AVC engine is good, but a redundancy mechanism is active (one LAN down but the other is still up) or a non-fatal hardware problem exists (fans too slow, temperature higher than expected, etc.)

Fault – AVC engine is stopped, or hardware is malfunctioning or mis-configured

Missing – A piece of hardware, defined in the design, has not been discovered. AVC engine is not communicating with that piece of hardware.

Initializing – Starting the firmware, configuration update, or design update.

Not Present – A virtual component in the design, that is designated as Dynamically Paired, and Not Required, has no hardware assigned to it.

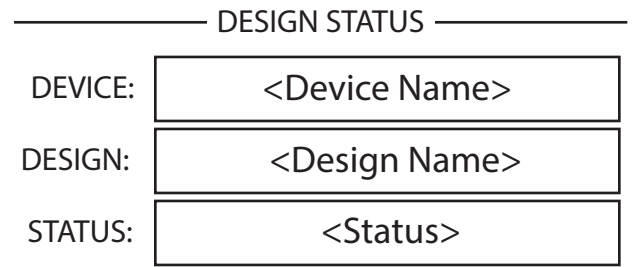

— Figure 3 —

System Status

Refer to Figure 4.

- **Firmware** – A three-section number identifying the major release, minor release, and maintenance release. For example, 6.0.0.
- **Temp** – The current chassis temperature of the Core.
- **Fan Speed** – This number varies with the temperature.

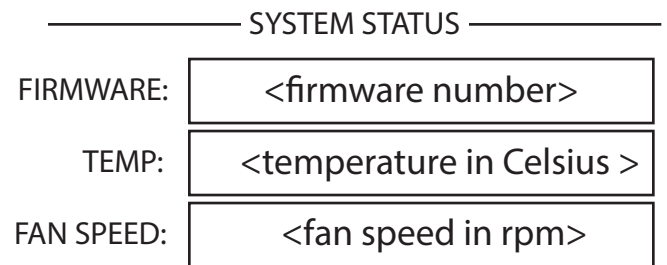

— Figure 4 —

LAN A

Refer to Figure 5.

You can edit this information in the Q-SYS Configurator.

- **Static or Auto** – Displays next to LAN A, indicates if the Core's IP Address is Static or Automatic.
- **IP Address** – The IP Address assigned to the Core's LAN A. LAN A is the primary Q-LAN connection to the Core, and is required.
- **Net Mask** – The Net Mask assigned to the Core.
- **Gateway** – The Gateway assigned to the Core.

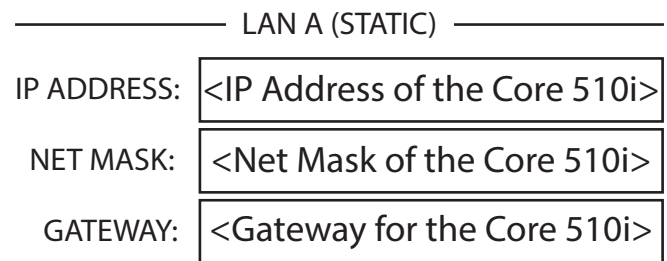

— Figure 5 —

LAN B

LAN B is used for redundancy or segregation of various data types on to different networks but is not required for device operation. The information is displayed in the same format as LAN A.

LAN AUX

LAN AUX is used for remote monitoring, WAN and VOIP connectivity, and is not required. The information is displayed in the same format as LAN A.

Slots A - H

















There is a total of 8 slots that can accommodate any combination of Q-SYS I/O Cards that are Type 2 format. The status for these cards are shown on the front panel by pressing the NEXT button shown in Figure 3.

Mic/Line In H.P. card Status (CIML4-HP)

Refer to Figure 6 (Mic/Line In H.P. card screen shown.)

The Mic/Line In H.P. card status screen shows the Mute state, Signal presence, Clip indication and +48V state of each of the 4 input channels.

- **Mute** – Displays a "muted loudspeaker" when the channel is muted.
- **Signal** – Displays a solid circle when there is a signal present on the associated channel.
- **Clip** – Displays a solid circle under the channel having an output signal over driving the associated channel output.
- **+48V** - Displays a solid circle when phantom power is active on the associated channel.

Slot	1	2	3	4	Mic/Line In - H.P.
Mute					
Signal					
Clip					
+48V					

















— Figure 6 —

Mic/Line In Std. card Status (CIML4)

Refer to Figure 7 (Mic/Line In Standard card screen shown.)

The Mic/Line In Standard card status screen shows the Mute state, Signal presence, Clip indication and +48V state of each of the 4 input channels.

- **Mute** – Displays a "muted loudspeaker" when the channel is muted.
- **Signal** – Displays a solid circle when there is a signal present on the associated channel.
- **Clip** – Displays a solid circle under the channel having an output signal over driving the associated channel output.
- **+48V** - Displays a solid circle when phantom power is active on the associated channel.

Slot	1	2	3	4	Mic/Line In - Std
Mute					
Signal					
Clip					
+48V					













— Figure 7 —

Line Out card Status (COL4)

Refer to Figure 8 (Line Out card screen shown.)

The Line Out card status screen shows the Mute state, Signal presence, and Clip status of each of the 4 output channels.

- **Mute** – Displays a "muted loudspeaker" when the channel is muted.
- **Signal** – Displays a solid circle when there is a signal present on the associated channel.
- **Clip** – Displays a solid circle under the channel having an output signal over driving the associated channel output.

Slot	1	2	3	4	Line Out
Mute					
Signal					
Clip					

— Figure 8 —

Dataport Out card Status (CODP4)

Refer to Figure 9 (Dataport Out card screen shown.)

The Dataport Out card status screen shows the Mute state, Signal presence, and connected amplifier status for both ports.

- **Mute** – Displays a "muted loudspeaker" when the channel is muted.
- **Signal** – Displays a solid circle when there is a signal present on the associated channel.
- **Amp 1** – Displays the status of the connected amplifier.
- **Amp 2** - Displays the status of the connected amplifier.

Slot	1	2	3	4	Dataport Out
Mute					
Signal	●	○	○	●	
Amp 1	OK				
Amp 2	Amp not present in design				

— Figure 9 —

AES3 card Status (CAES4)

Refer to Figure 10 (AES3 card screen shown.)

The AES3 card status screen shows the Mute state, Signal presence, and Lock state for 4 input and 4 output channels.

- **Mute** – Displays a "muted loudspeaker" when the channel is muted.
- **Signal** – Displays a solid circle when there is a signal present on the associated channel.
- **Lock** – Displays a solid circle when the AES3 clock is in sync and locked.

Slot	In				Out				AES3			
	1	2	3	4	1	2	3	4	1	2	3	4
Mute												
Signal	●	○	○	●	●	○	○	●	●	○	○	●
Lock	●	○	○	●	●	○	○	●	●	○	○	●

— Figure 10 —

16 channel AES3 In card Status (CIAES16)

Refer to Figure 11 (16 Channel AES3 In card screen shown)

The AES3 16 channel card status screen shows the Signal presence, and Lock state for all 16 input channels.

- **Signal** – Displays a solid circle when there is a signal present on the associated channel.
- **Lock** – Displays a solid circle when the AES3 clock is in sync and locked for the associated channel.

Slot	Signal/Lock		16 Channel AES3 In			
1	●/●	2 ●/●	3 ●/●	4 ●/●	5 ○/○	6 ○/○
7	●/●	8 ○/○	9 ●/●	10 ●/●	11 ●/●	12 ●/●
13	○/○	14 ○/●	15 ○/●	16 ○/○		

— Figure 11 —

AVB card Status (CAN32)

Refer to Figure 12 (AVB card screen shown)

The AVB card status screen shows the Status of the card, Link state and speed of the network connection, and the MAC address of the card itself.

- **Status** – Displays the status of the AVB card.
- **Link** – Displays a solid circle when there is a valid connection with an AVB network or device and indicates the network connection speed in Mbps.
- **MAC** – Displays the MAC (Media Access Control) address of the AVB card.

Slot	AVB
Status:	OK
Link:	● 100
MAC:	02:36:dd:c0:ed:0b

— Figure 12 —

CobraNet card Status (CCN32)

Refer to Figure 13 (CobraNet card screen shown)

The CobraNet card status screen shows the Activity state, Fault state, In Use state and Conductor state of the Primary and Secondary network ports.

- **Activity** – Displays a solid circle when the Primary or Secondary port is active.
- **Fault** – Displays a solid circle under the channel having a communication fault while sending or receiving a bundle.
- **In Use** – Displays a solid circle when there is an active connection to a CobraNet network or device on the associated LAN port (primary or secondary.) The image shows that the secondary port is active.
- **Conductor** - Displays a solid circle when the Primary or Secondary port is the Conductor.

Slot	Primary	Secondary	CobraNet
Activity	●	●	
Fault	●	○	
In Use	○	●	
Conductor	○	●	

— Figure 13 —

Dante card Status (CDN64)

Refer to Figure 14 (Dante card screen shown)

The Dante card status screen shows the Status of the card, Link state and connection speed of the Primary and Secondary network ports, and the Name of the device as seen by other Dante devices on the network.

- **Status** – Displays the status of the Dante card.
- **Link** – Displays a solid circle when there is a valid connection with a Dante network or device. The image shows that the Primary port has established a link at 1000 Mbps.
- **Name** – Displays the name of the Dante device that will be seen by other connected Dante devices.

Slot	Dante	
Status:	OK	
Link:	Primary ● 1000	Secondary ○ N/A
Name:	Dante-Device-Name	

— Figure 14 —

Connections

AC Power Cord

Insert the molded IEC receptacle connector of the AC power cord into the IEC AC power inlet on the back of the Q-SYS Core. See Figure 15. Insert the AC line connector into an AC outlet. The Q-SYS core will accept 100-240 VAC, 50-60Hz.

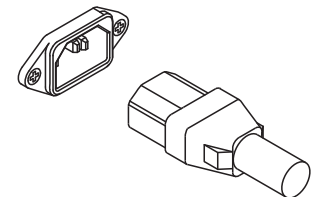

— Figure 15 —

Q-SYS LAN A, LAN B, AUX Network Connections

Connect one end of a Ethernet cable (CAT-6 or better) terminated with a RJ45 plug into the LAN A or optional LAN B receptacle on the back of the Q-SYS Core. The AUX network connection can be used for WAN streaming, remote control or monitoring. See Figure 16.

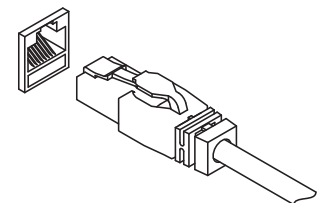

— Figure 16 —



NOTE: The addition of AES67 streams are supported over the LAN A and B networks.

Mic/Line Inputs, Line Outputs, AES3 I/O

All of these type of I/O cards accept Euro-style 3-pin connectors. See Figure 17. When these cards are ordered in the product configuration, the mating plugs are included in the product shipping carton. Plug the included Euro-style connectors into the appropriate input/output connector on the Q-SYS I/O Card. The connection pinout is indicated on the cards mounting bracket. Refer to illustrations on the right hand column of this page for balance and unbalanced connections.

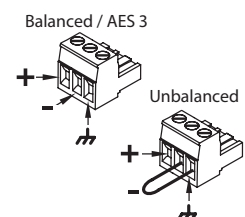

— Figure 17 —

DataPorts

The Q-SYS DataPort I/O card is intended to interface with QSC amplifiers with v1 DataPorts, which is supported on the CX, DCA, PowerLight™, PL2, and PL3 series amplifiers. All DataPort cables use HD15 connectors. See Figure 18.

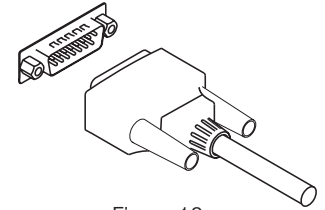

— Figure 18 —



IMPORTANT!: These may appear to be common VGA cables, but they are not. Many of the off-the-shelf VGA cables may appear to work with satisfactory results. However, it is possible these same cables may not consistently work in a satisfactory manner and could damage QSC amplifiers they are attached to. The QSC DataPort specification requires that all 15 connections be present in the cable and that there is proper shielding for the audio conductor pairs that run to the QSC amplifier. Therefore, QSC recommends the use of QSC DataPort cables exclusively, which are available in a variety of lengths from QSC. Use of any non-QSC DataPort cable may void the Core 510 product warranty.

Connect the QSC DataPort cable from the HD15 connectors on the DataPort Card to the QSC amplifiers. Note that multi-channel amps can spread across multiple DataPort IO cards, as long as they are in the same Core or IO Frame.

Audio Network Cards and 16-Channel AES3 Input Card (CIAES16)

Audio Network I/O cards provide a bridge between Q-SYS audio networks and products and systems incorporating 3rd party audio network technologies. All QSC audio network cards include RJ45 receptacles that accommodate standard data communications cables, terminated with RJ45 plugs. High capacity AES3 input (16 channel) cards also use RJ45 receptacles. See Figure 19.

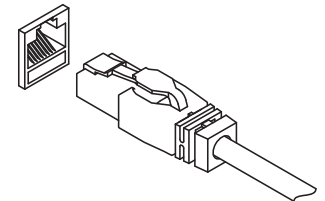

— Figure 19 —

GPIO Pin Assignments

DB15 Pin	Signal Name	Signal Type	Description
1	RNO	Relay Contact	Relay - normally open
2	RNC	Relay Contact	Relay - normally closed
3	GPIO 1	Normal Current	GPIO pin
4	GPIO 3	Normal Current	GPIO pin
5	POWER	Power	+ 12V DC
6	GPIO 5	High Current	GPIO pin -high current capable
7	GPIO 7	High Current	GPIO pin -high current capable
8	GND	Ground	Ground
9	RC	Relay Contact	Relay - common
10	GND	Ground	Ground
11	GPIO 2	Normal Current	GPIO pin
12	GPIO 4	Normal Current	GPIO pin
13	POWER	Power	+ 12V DC
14	GPIO 6	High Current	GPIO pin -high current capable
15	GPIO 8	High Current	GPIO pin -high current capable

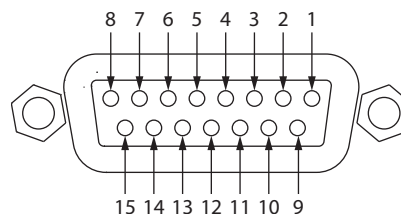

GPIO Specifications

Relay Pins	Normal Current Pins	Discription
Maximum Voltage, relative to Ground: 30V	Maximum Input Range: 0 V to 32 V	Maximum Input Range: 0 V to 32 V
Maximum Current through Relay: 1 Amp	Analog Input Range: 0 V to 24 V	Analog Input Range: 0 V to 24 V
		Digital Input, Low: 0.8 V maximum
		Digital Inpput, High: 2.0 V minimum
Power Pins		Digital Output, Low: 0.4 V maximum
Output Voltage: 11 V min, 13 V max		Digital Output, High: 2.4 V min, 3.3 V max
Maximum Output Current: 400 mA		Digital Output Impedance: 1K Ohm
		High Current Output, Low: 0.4 V maximum
	High Current Output, High: Not supported	High Current Output, High: 11 V min, 13 V max
	High Current Output, sink: 280 mA	High Current Output, sink or source: 280 mA
	High Current Output, source: Not supported	



NOTE: The maximum current sourced by one GPIO connector (including both High Current and Power Pins) is 400mA.

GPIO Examples

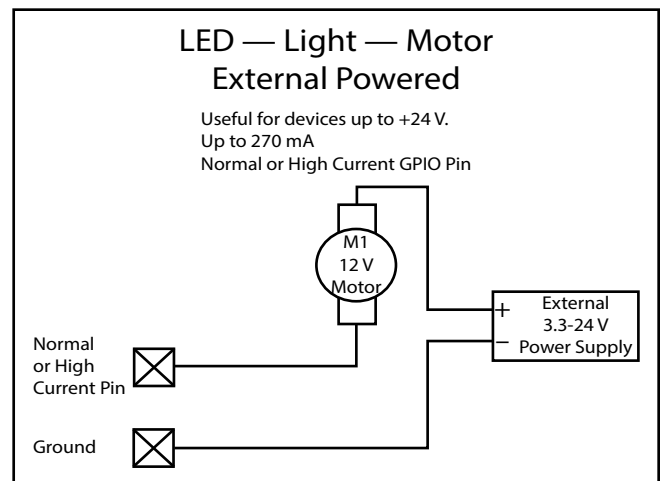
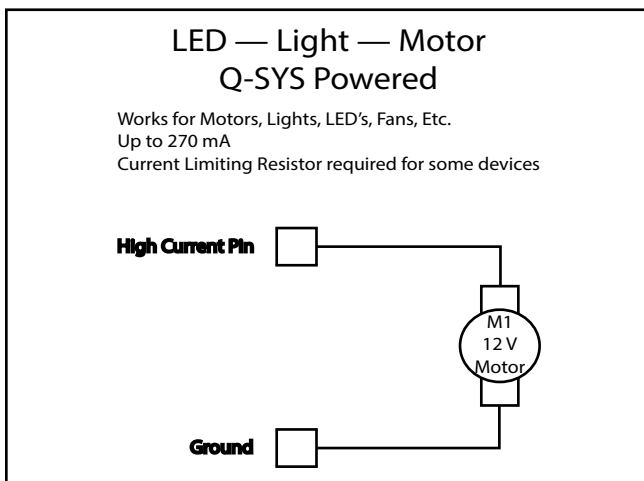
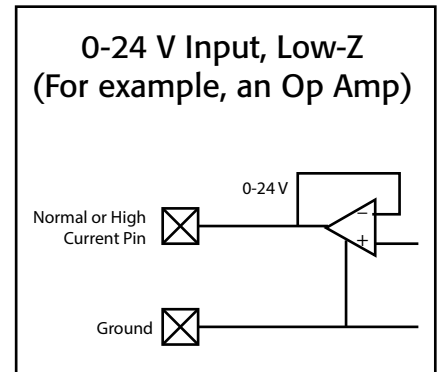
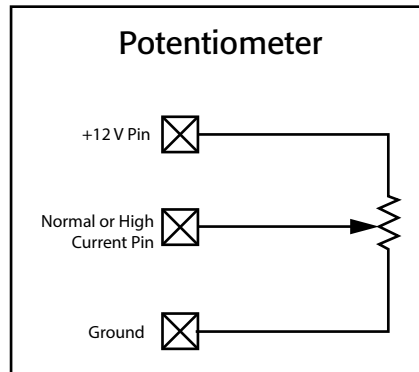
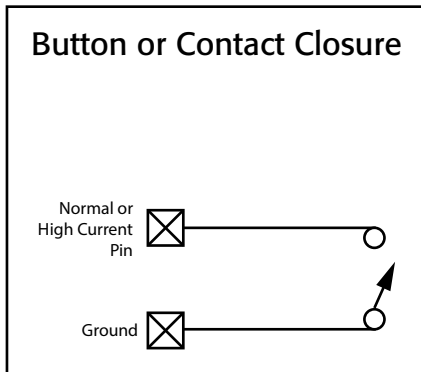

Directional Motor Control

Use PWM and Inverted PWM to control speed and direction.
Output is similar to an H-Bridge topology.

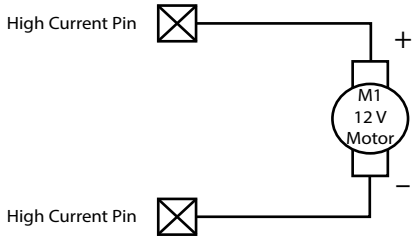

Rotary Encoder

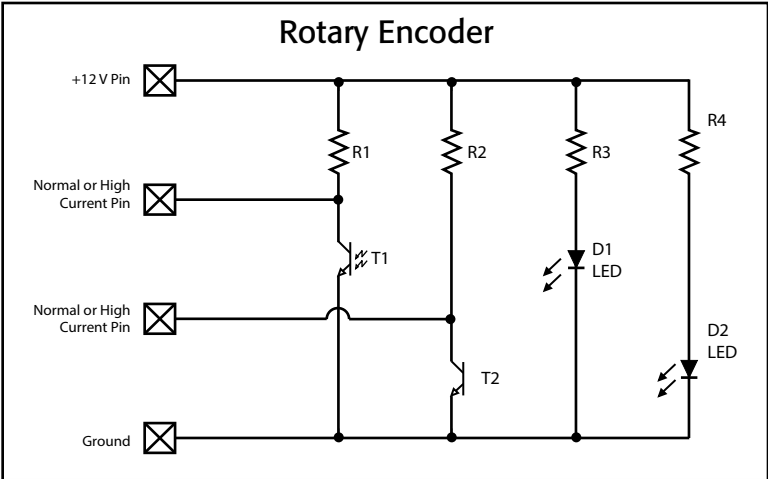

Rotary Switch

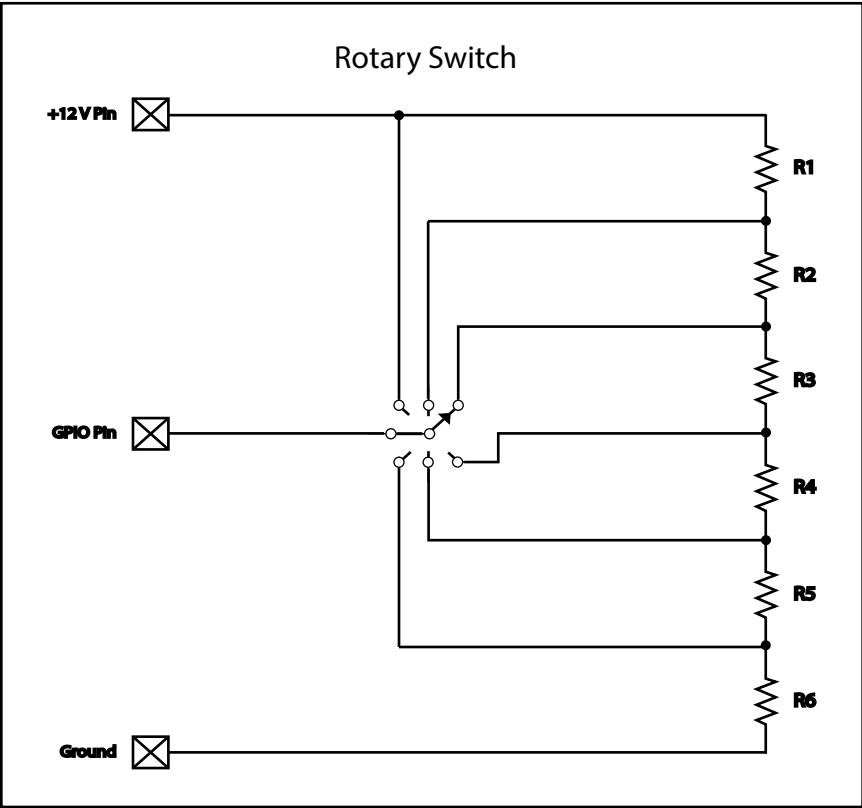

Q-SYS I/O Card Remove and Replace Procedure

This procedure is for Q-SYS Type 2 I/O Cards only. Card installation should only be done by a trained and qualified technician.

Tools

- Phillips screwdriver
- ESD grounded wrist strap
- 1/4" hex driver/socket (not shown) for replacing Q-SYS I/O cards in slots A through F.

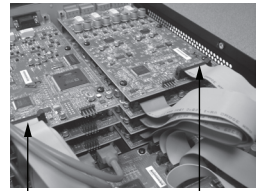

— Figure 20 —



CAUTION! An ESD grounded wrist strap must be worn throughout the remove and replace procedure. The end of the wrist strap should be connected to an unpainted surface on the product chassis such as a ground stud.

1. Disconnect the AC mains power cord from the Q-SYS Core.
2. Connect and put on the ESD grounded wrist strap.
3. Remove the sheet metal screws securing the lid to the Q-SYS Core chassis. Remove the lid by lifting it approximately 1" at the rear of the chassis while sliding it towards the back.
4. Locate the I/O Card to be replaced and remove the ribbon cable (Figure 21) from the card by gently pushing outward on the cable ejector tabs. The connector should be free of the socket.
5. Remove the two screws securing the I/O Card Mounting Bracket (Figure 22) on the rear of the chassis. Remove the bracket.
6. Remove the I/O Cards: Refer to Figure 23.
 - a. For cards in positions G or H, remove the four Phillips head screws securing the card to the standoffs. Remove the card. If you are not replacing a card in position A through F, skip to step 7.



NOTE: Figure 23 shows both standoffs and screws for illustration purposes. The screws are only used on cards in positions G and H. All other cards must use the standoffs.

- b. For cards in positions A through F, remove the cards in positions G and/or H (step 6.a), then remove the four hex standoffs securing the next lower card, and remove the card. Continue this until you have removed the card you wish to replace.



WARNING! Domestic and international safety regulations require that this device (Q-SYS Cores) be fully configured before power is applied. All eight audio I/O card bays designated A through H, must include a Q-SYS Audio I/O card and mounting bracket or a rear plate assembly (RP-1). See (Figure 22). Failure to properly configure this device will void the warranty.

7. Install the new I/O Card by reversing steps 5 and 6. Be sure to align and secure the I/O Card Mounting Bracket before tightening the hex standoffs or card-securing screws. Complete step 7 and 8 for each single level, or layer, of cards as you replace them. Do not move to the next level of cards until the lower level is properly installed.
8. Reconnect the ribbon cable to the I/O Card, by aligning the tab on the cable connector housing with the key on the card connector as shown in Figure 24. Gently push down on the cable connector housing to seat the cable into the card connector. When properly seated, the cable ejectors will lock in place with the thumb tabs upright.
9. When you connect the ribbon cable to the Core main board be sure that you connect it to the proper connector. The connectors on the Core main board are identified by the slot letters A through H.

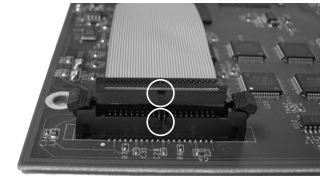

— Figure 21 —

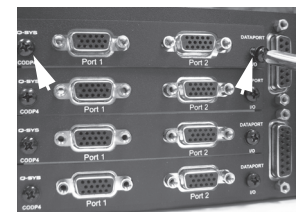

— Figure 22 —

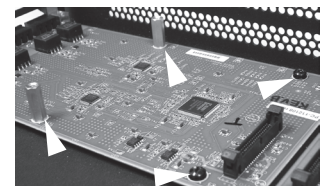

— Figure 23 —

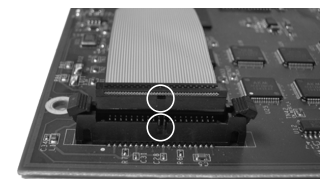

— Figure 24 —

Qualified Ethernet Switches

Q-SYS uses layer 3 (DSCP) QoS. The implementation of this type of QoS on a given network switch can vary depending on the manufacturer and switch model. For more details about network and switch setup, refer to the Help File in Q-SYS Designer.



NOTE: For a list of currently-qualified switches please visit qsc.com and search for “Q-SYS Switches”.

Dimensions

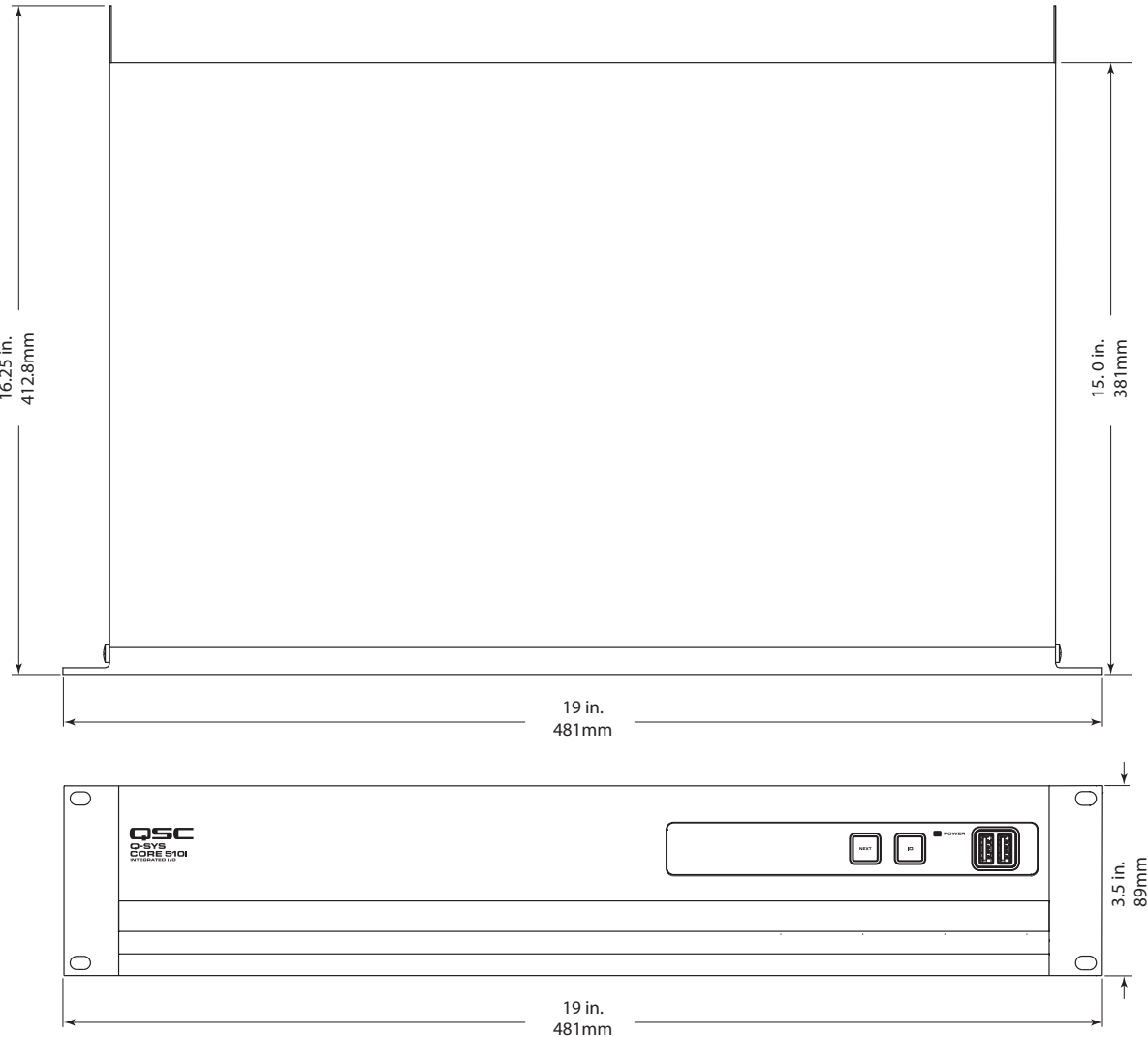

— Figure 25 —

Q-SYS Core 510 Series Specifications

Description	Audio, Video and Control processing engine with integrated I/O (or I/O Frame peripheral for I/O expansion)
Operation Mode	"Core" mode - Audio, Video and Control processing engine for Q-SYS system with 8, Type 2 I/O card slots for high channel count operation "I/O Frame" mode - I/O expansion with 8, Type 2 I/O card slots for high channel count operation
Software Requirements	6.0.0 or higher

Capacities

Network Channel Capacity	256 x 256 ("Core" mode), 128 x 128 ("I/O Frame" mode)
I/O Capacity	8 audio I/O card slots - accomodates up to 128 x 128 total onboard I/O channels
AEC Capacity	510i: 64 processors at 200ms tail length (available in "Core" mode only) 510c: 16 processors at 200ms tail length (available in "Core" mode only)
Multitrack Player Capacity	16 tracks, expandable to 128 tracks (accessible in "Core" mode only, note: 32, 64 or 128 track upgrade options are available)
Media Drive Capacity	Approximately 6GB on the internal drive (accessible in "Core" mode only, note: upgrade options are available)
I/O Card Options	COL4: Line Output card (4 channels) CODP4: DataPort card (4 channels) CIML4: Standard Mic/Line Input card (4 channels) CIML-HP: High Performance Mic/Line Input card (4 channels) CAES4: AES3 Digital I/O card (4 x 4 channels) CIAES16: AES3 Digital Input card (16 channels) CCN32: CobraNet Network Bridge card (up to 32 x 32 channels) CAN32: AVB Network Bridge card (up to 32 channels) CDN64: Dante Network Bridge card (up to 64 x 64 channels)
Media Drive Options	M2-MD-S: 128GB M2-MD-M: 256GB M2-MD-L: 512GB
Multitrack Player Options	MTP-32: 32 tracks of simultaneous media file playback MTP-64: 64 tracks of simultaneous media file playback MTP-128: 128 tracks of simultaneous media file playback * MTP Options require the purchase of a Media Drive (128 GB or larger)

Controls and Indicators

Front Panel Controls	"NEXT" OLED page forward capacitive touch button "ID" capacitive touch button "Clear Network Settings" invoked when "NEXT" and "ID" buttons are pressed simultaneously
Front Panel Connectors	AUX USB: USB Host x 2 (Type A connections)
Front Panel Indicators	Blue "POWER" LED 304 x 96 monochrome OLED display
Rear Panell Connections	RS232: Male 9-pin D shell connector (9-pin) Video Out: HDMI AUX USB: USB Host x 4 (Type A connections) AUX Network: RJ45 10/100/1000 Mbps Management Network GPIO: Female 15-pin D shell connector x 2 (DA-15) Media Network LAN A: RJ45 1000 Mbps (QLAN, AES67, VoIP, WAN, Media Streaming, etc) Media Network LAN B: RJ45 1000 Mbps (QLAN, AES67, VoIP, WAN, Media Streaming, etc) AC Mains Power: IEC connector
Rear Panel Indicators	"Link", "Speed" and "Activity" LEDs on all LAN prots

Q-SYS Core 510 Series Specifications

Miscellaneous

Line Voltage	100 VAC - 240 VAC, 50-60 Hz
Current Draw	3.7A Max @ 100 VAC (actual current draw depends on configuration options such as; I/O cards and/or Media Drive, DSP and Network loading)
Operating Temperature Range	0°C - 50°C
BTU/Hour	600 (power conversion estimate under typical load)
Humidity	5-85% RH non-condensing
Expected Product Life Cycle	20 years
Product Storage Temperature	-20°C to +70°C
Regulatory	FCC 47 CFR Part 15 Class A, IC ICES-003, CE (EN55032, EN55035), EU RoHS directive 2011/65/EU, WEEE directive 2012/19/EU, China RoHS directive GB/T26572, EAC, RTL, UL, C-UL
Product Dimensions	3.5" x 19" x 15" (89mm x 483mm x 381mm)
Shipping Carton Dimensions	6.5" x 23.5" x 20" (17mm x 60mm x 51mm)
Shipping Weight	23 lbs minimum (installation of I/O cards increases shipping weight)
Included Accessories	An AC power cord (one of four options for cords are available), Safety Information and Regulatory Statements (TD-001514-01), Audio I/O connector kit (when purchasing I/O Cards with Euro-style terminal blocks), Warranty Statement (TD-000453-01)

Specifications subject to change without notice.



Mailing Address:

QSC, LLC
1675 MacArthur Boulevard
Costa Mesa, CA 92626-1468 U.S.
Main Number: (714) 754-6175
World Wide Web: www.qsc.com

Sales & Marketing:

Voice: (714) 957-7100 or toll free
(U.S. only) (800) 854-4079
FAX: (714) 754-6174
E-mail: info@qsc.com

Q-SYS™ Customer Support

Application Engineering and Technical Services
Monday - Friday 7 AM to 5 PM PST (Excludes Holidays)
Tel. 800-772-2834 (U.S. only)
Tel. +1 (714) 957-7150

Q-SYS 24/7 Emergency Support*

Tel: +1-888-252-4836 (U.S./Canada)
Tel: +1-949-791-7722 (non-U.S.)

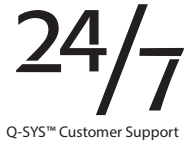

*Q-SYS 24/7 Support is for Emergency assistance with Q-SYS systems only. 24/7 support guarantees a call back within 30 min after a message is left. Please include, Name, Company, Call Back Number and description of the Q-SYS emergency for prompt call back. If calling during business hours please use the standard support numbers above.

Q-SYS Support Email

qsyssupport@qsc.com
(Immediate email response times not guaranteed)

QSC

Technical Services
1675 MacArthur Blvd.
Costa Mesa, CA 92626 U.S.
Tel: 800-772-2834 (U.S. only)
Tel: +1 (714) 957-7150
FAX: +1 (714) 754-6173

© 2017 QSC, LLC. All rights reserved. QSC and the QSC logo are registered trademarks of QSC, LLC in the U.S. Patent and Trademark office and other countries. Q-SYS, Q-LAN and, Q-SYS Designer are trademarks of QSC, LLC. Patents may apply or be pending.

All other trademarks are the property of their respective owners.

<http://patents.qsc.com>